

R1.41 - REGAŁ 40 3P

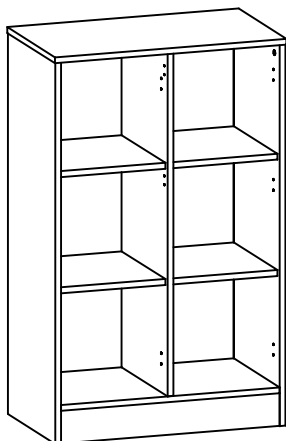

R2.46 - REGAŁ 75 3P

Regał 3P

Bookcase 3P

Стелаж 3P

Etajera 3P

Regal 3P

Kirjahyllya 3P

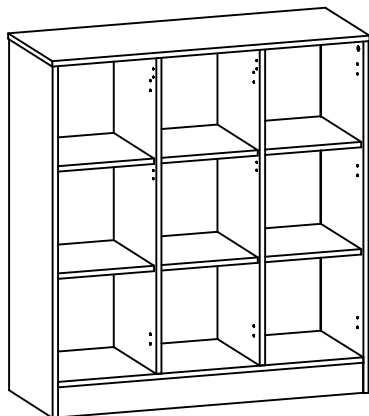

R3.41 - REGAŁ 110 3P

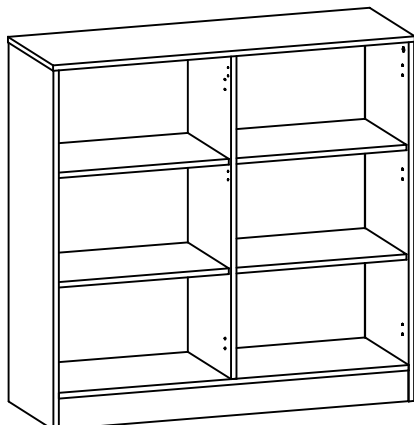

R2.49 - REGAŁ 120 3P

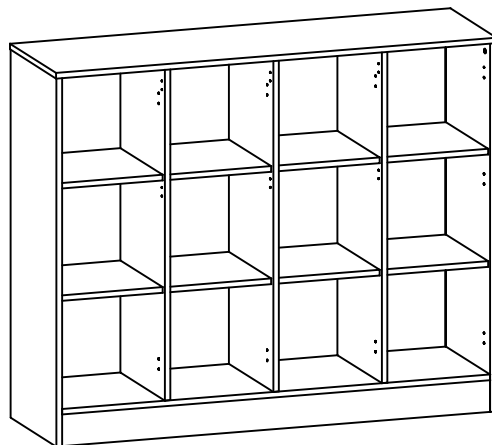

R4.41 - REGAŁ 145 3P

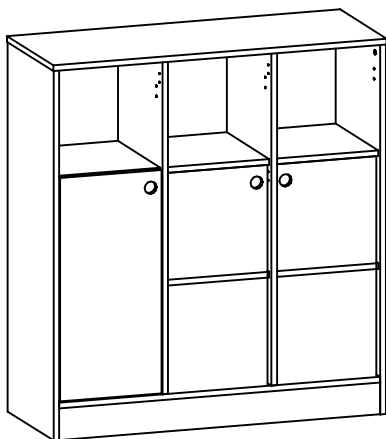

R3.43 - REGAŁ 110 3PF

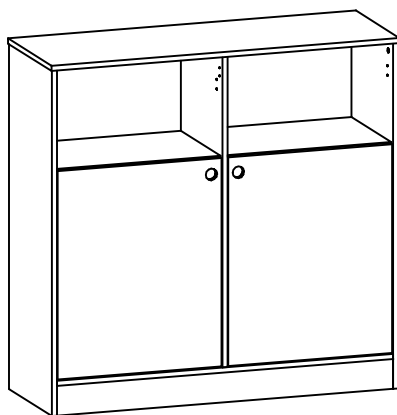

R2.48 - REGAŁ 120 3PF

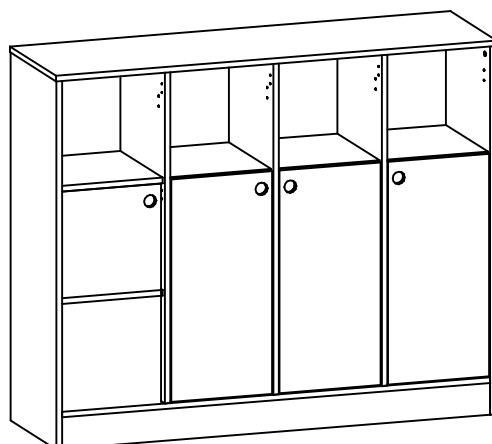

R4.42 - REGAŁ 145 3PF

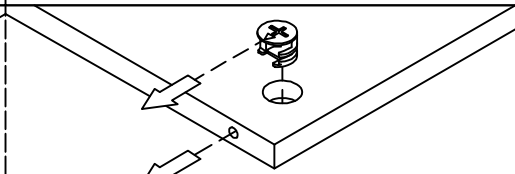
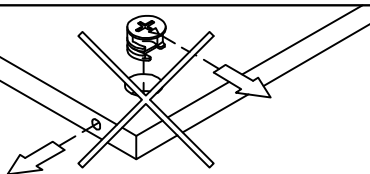
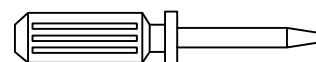
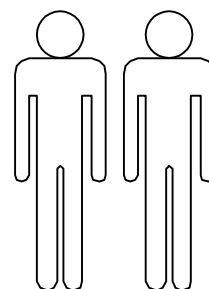
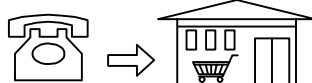
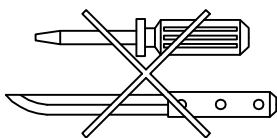
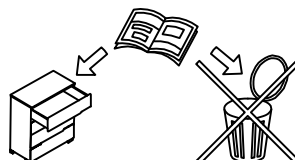
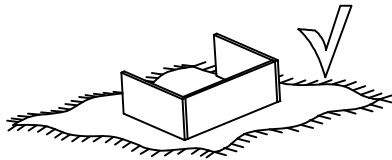
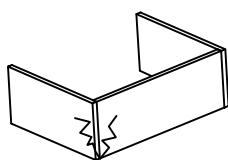

meblik

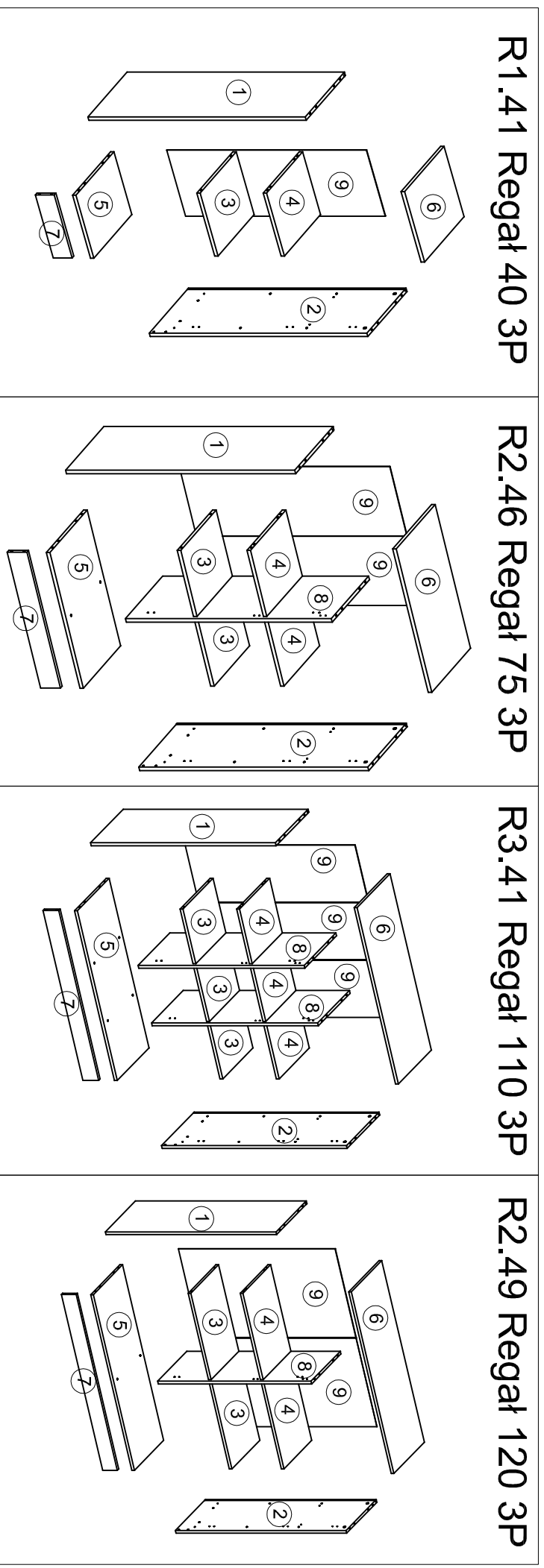

ELEMENTS / CZĘŚCI / ДЕТАЛИ / COMPONENTE / TEILE /ELEMENTIT

Nr	A x B x C (mm)	PCS.	Nr	A x B x C (mm)	PCS.	Nr	A x B x C (mm)	PCS.	Nr	A x B x C (mm)	PCS.
1	1162x420x18	1	1	1162x420x18	1	1	1162x420x18	1	1	1162x420x18	1
2	1162x420x18	1	2	1162x420x18	1	2	1162x420x18	1	2	1162x420x18	1
3	336x387x18	1	3	336x387x18	2	3	336x387x18	3	3	576x387x18	2
4	336x387x18	1	4	336x387x18	2	4	336x387x18	3	4	576x387x18	2
5	336x407x18	1	5	690x407x18	1	5	1044x407x18	1	5	1170x407x18	1
6	376x424x18	1	6	730x424x18	1	6	1084x424x18	1	6	1210x424x18	1
7	336x100x18	1	7	690x100x18	1	7	1044x100x18	1	7	1170x100x18	1
9	1067x352x3	1	8	1044x407x18	1	8	1044x407x18	2	8	1044x407x18	1
			9	1067x352x3	2	9	1067x352x3	3	9	1067x590x3	2

R4.41 Regał 145 3P

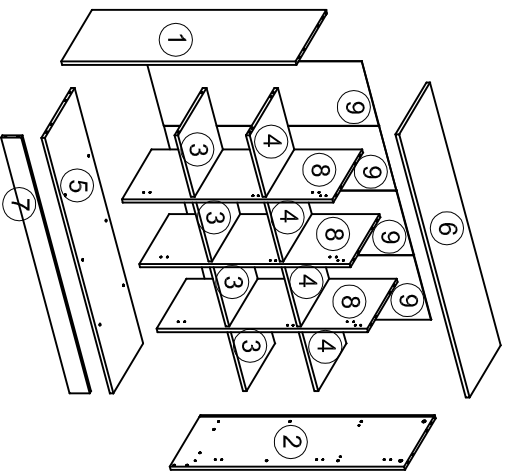

R3.43 Regał 110 3PF

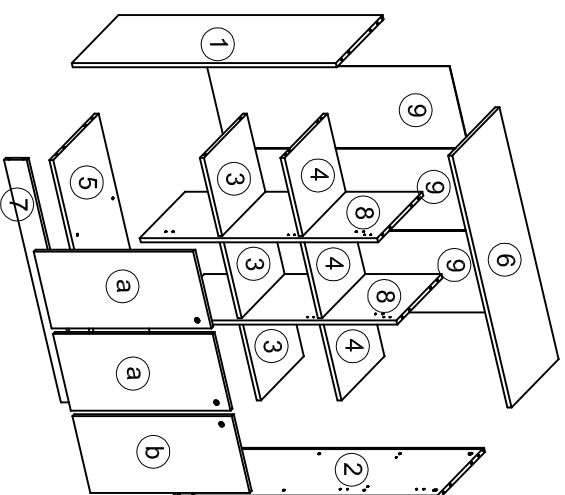

R2.48 Regał 120 3PF

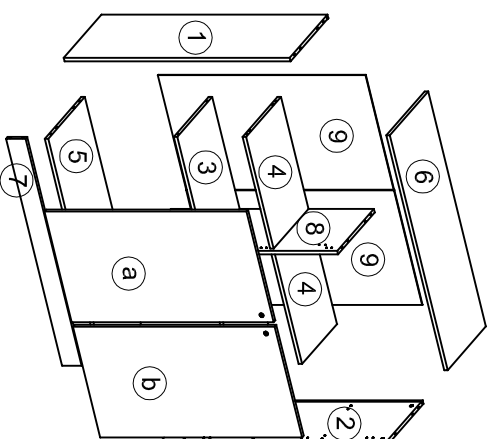

R4.42 Regał 145 3PF

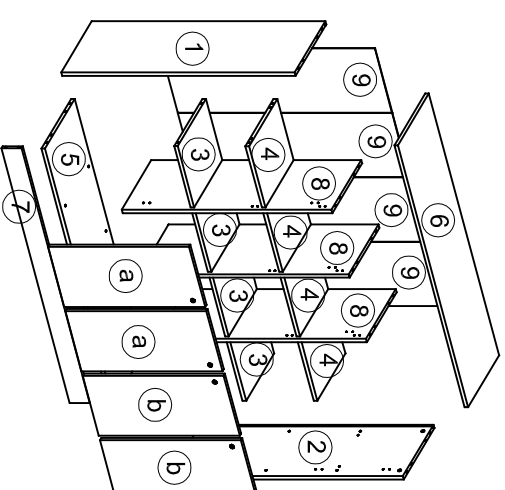







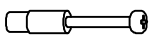
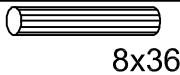
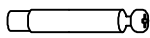
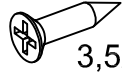
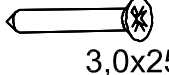
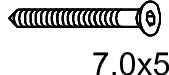

ELEMENTS / CZĘŚCI / ДЕТАЛИ / COMPONENTE / TEILE /ELEMENTIT

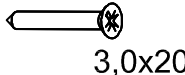
Nr	A x B x C (mm)	PCS.	Nr	A x B x C (mm)	PCS.	Nr	A x B x C (mm)	PCS.	Nr	A x B x C (mm)	PCS.
1	1162x420x18	1	1	1162x420x18	1	1	1162x420x18	1	1	1162x420x18	1
2	1162x420x18	1	2	1162x420x18	1	2	1162x420x18	1	2	1162x420x18	1
3	336x387x18	4	3	336x387x18	3	3	576x387x18	2	3	336x387x18	4
4	336x387x18	4	4	336x387x18	3	4	576x387x18	2	4	336x387x18	4
5	1398x407x18	1	5	1044x407x18	1	5	1170x407x18	1	5	1398x407x18	1
6	1438x424x18	1	6	1084x424x18	1	6	1210x424x18	1	6	1438x424x18	1
7	1398x100x18	1	7	1044x100x18	1	7	1170x100x18	1	7	1398x100x18	1
8	1044x407x18	3	8	1044x407x18	2	8	1044x407x18	1	8	1044x407x18	3
9	1067x352x3	4	9	1067x352x3	3	9	1067x590x3	2	9	1067x352x3	4

Nr	A x B x C (mm)	PCS.	Nr	A x B x C (mm)	PCS.	Nr	A x B x C (mm)	PCS.
a	702x330x18	2	a	1038x570x18	1	a	702x330x18	2
b	702x330x18	1	b	1038x570x18	1	b	702x330x18	2

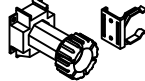
OKUCIA / FITTINGS / ФУРНИТУРА / FERONERIE / BESCHLÄGE / KIINNITTIMET

		REGAŁ 40 3P	REGAŁ 75 3P	REGAŁ 110 3P	REGAŁ 120 3P	REGAŁ 145 3P	REGAŁ 110 3PF	REGAŁ 120 3PF	REGAŁ 145 3PF
W1		12	18	24	18	30	24	18	30
W2		12	14	16	14	18	16	14	18
W4	 8x36	20	30	40	30	50	40	30	50
W9		-	4	8	4	12	8	4	12
W10	 3,5x16	-	-	8	8	8	8	16	24
W11	 3,0x25	6	18	34	30	48	34	30	48
W14	 7,0x50	-	2	4	2	6	4	2	6
W20		7	8	7	10	8	7	10	8
W63	 3,0x20	7	8	7	10	8	7	10	8
W24		1	1	1	1	1	1	1	1
W33	 S=4	1	1	1	1	1	1	1	1
W3		8	14	20	14	26	20	14	26
W21		-	6	16	6	24	16	16	24
		-	-	2	2	2	2	2	2
		-	-	-	-	-	6	4	8
		-	-	-	-	-	6	4	8

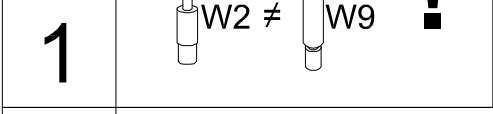
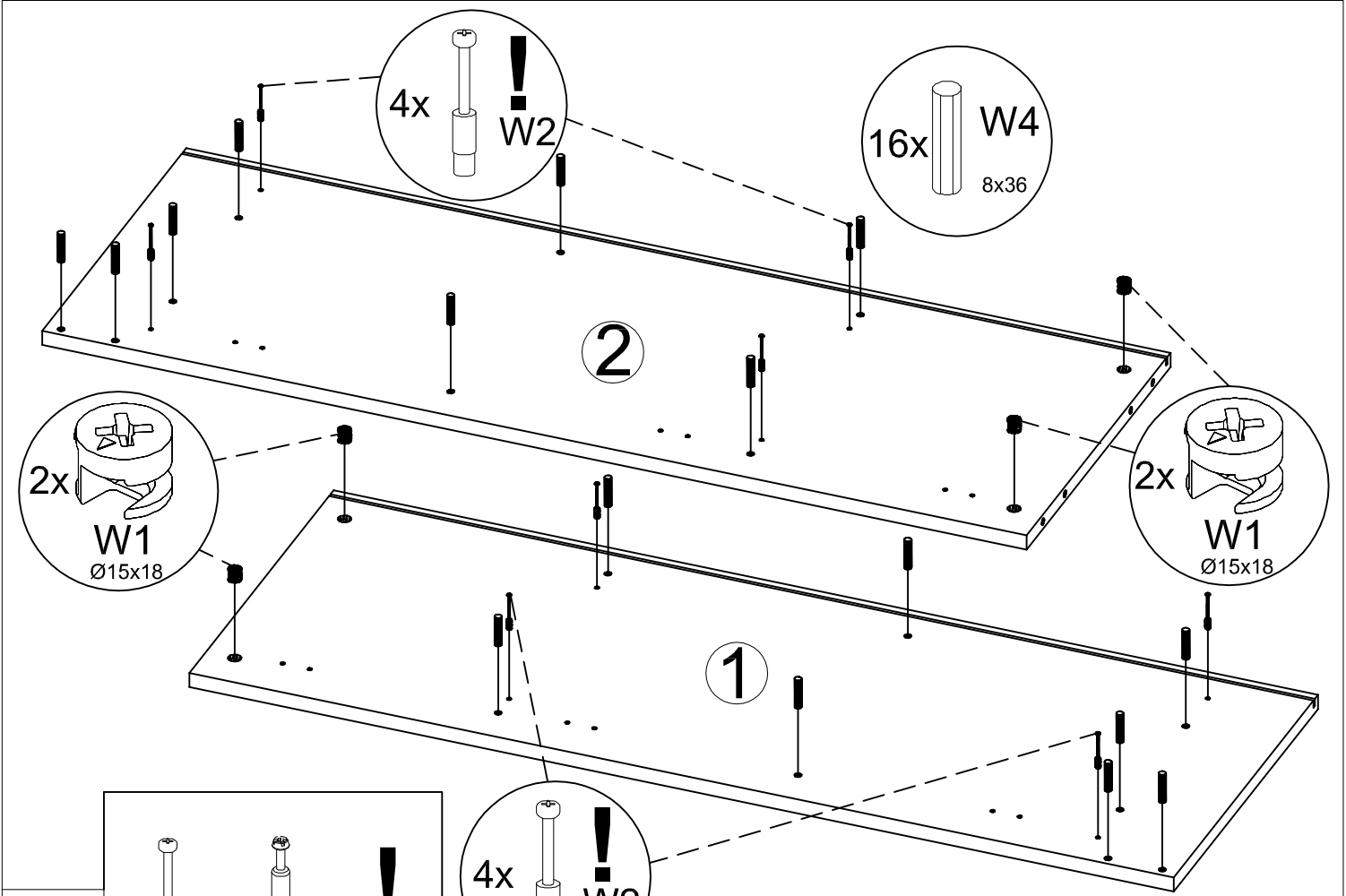

1

2

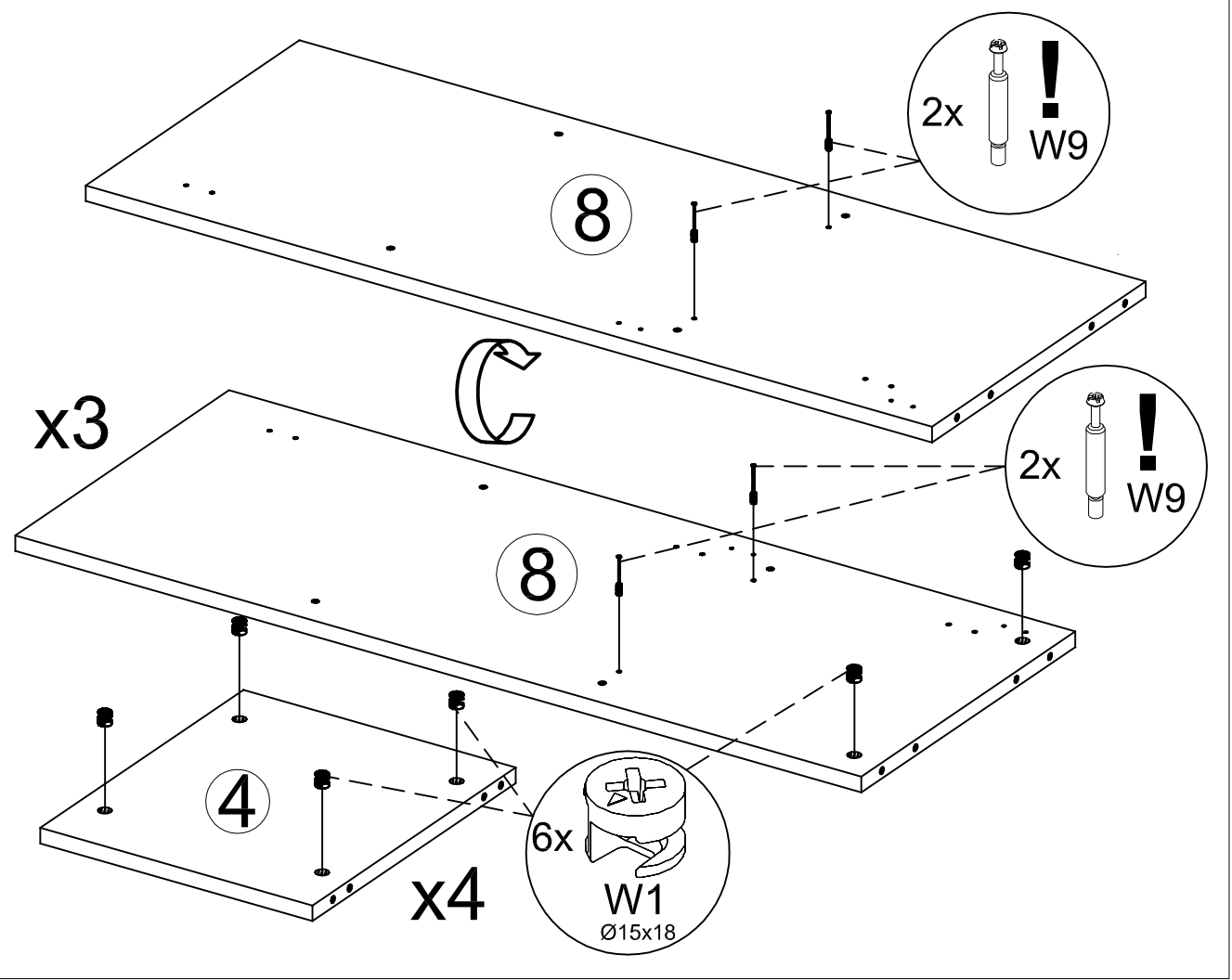

3

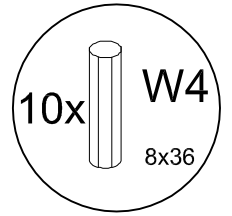
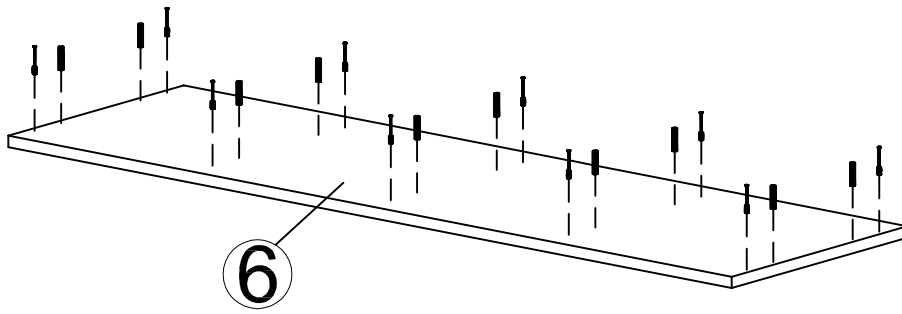
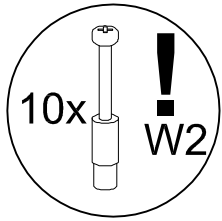

4

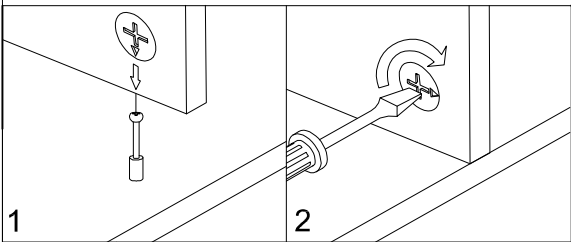
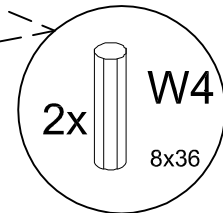
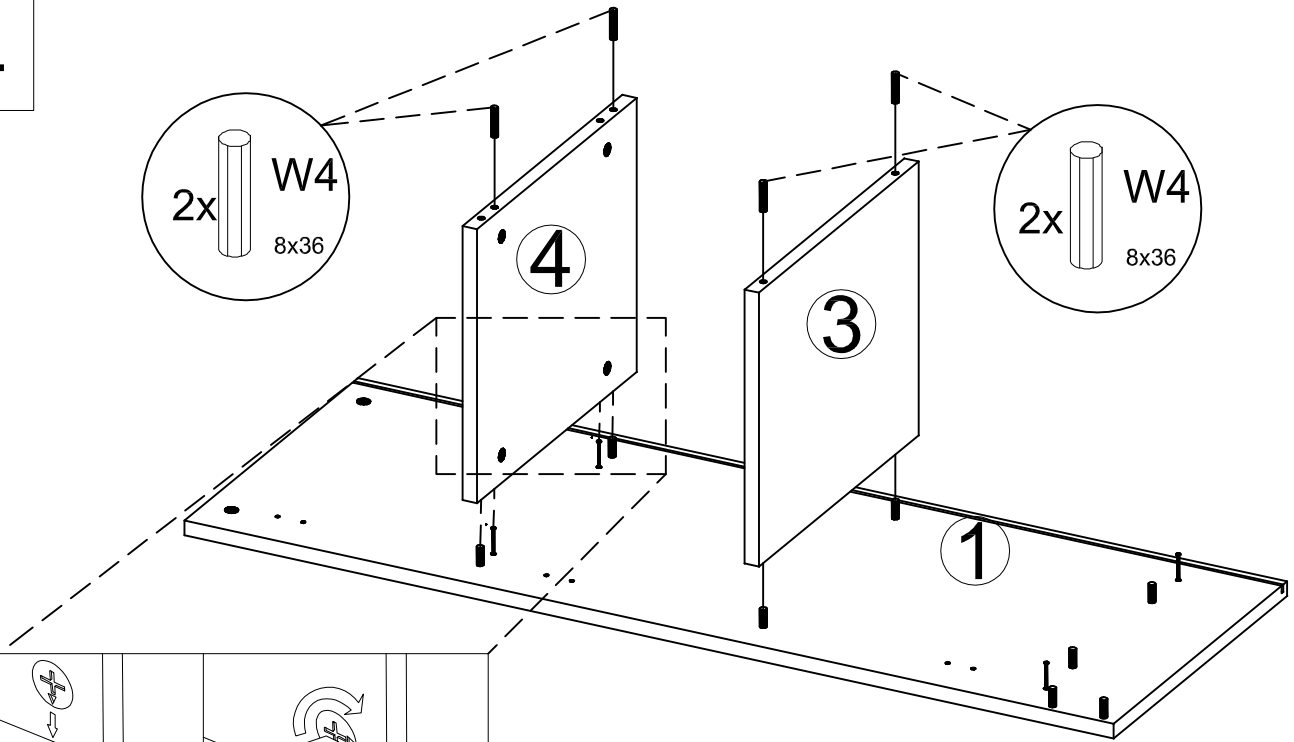
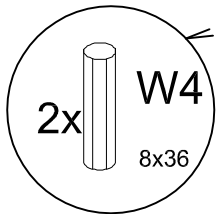

5

8

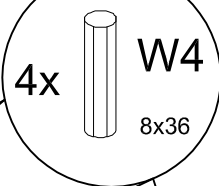

5

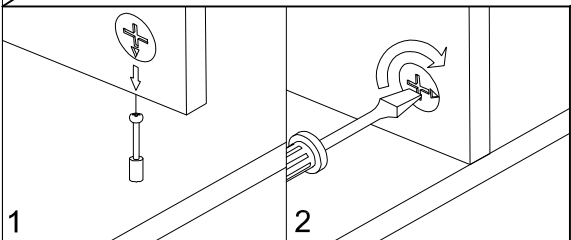
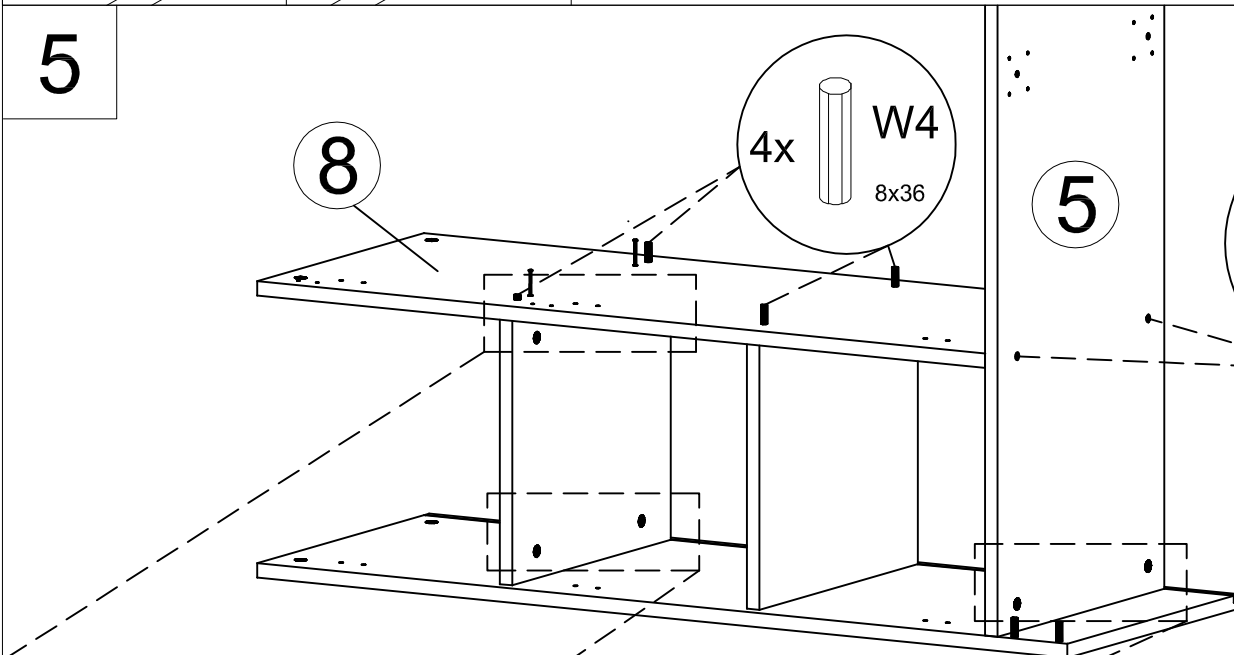
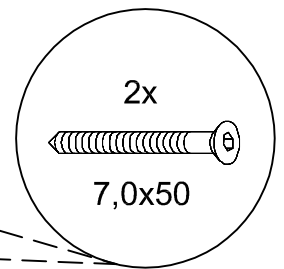

REGAL 145

REGAL 110

REGAL 75

REGAL 40

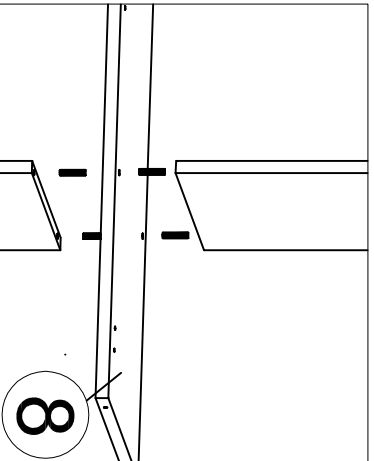
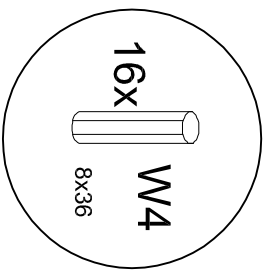
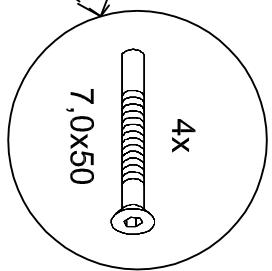
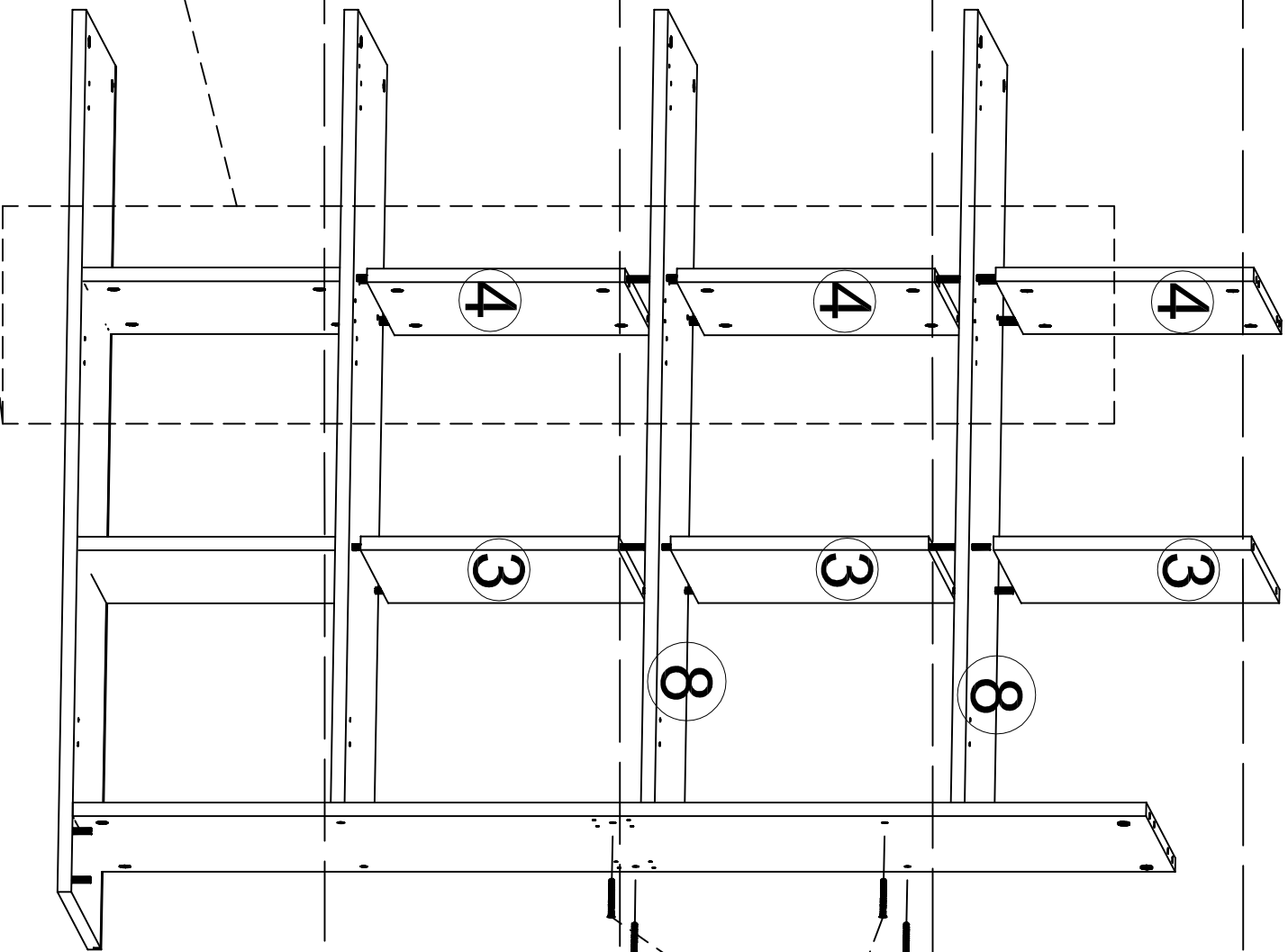
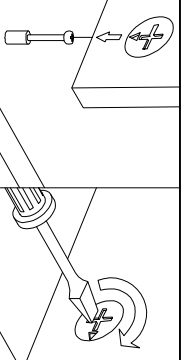

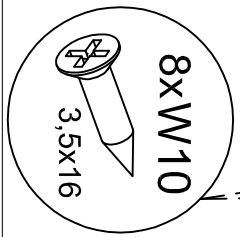
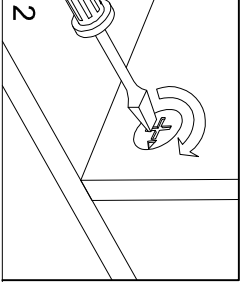
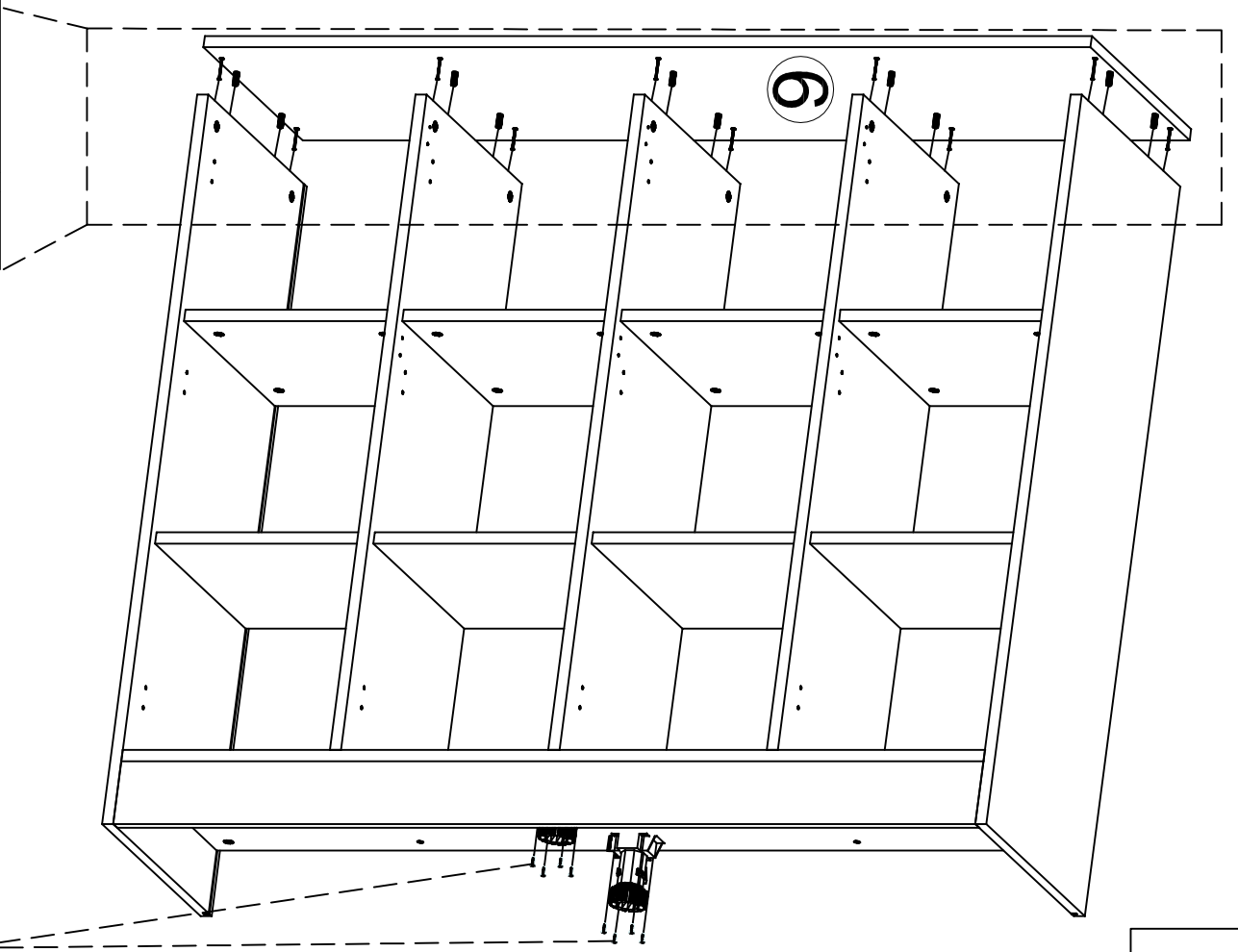
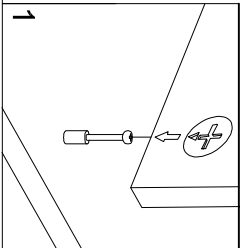
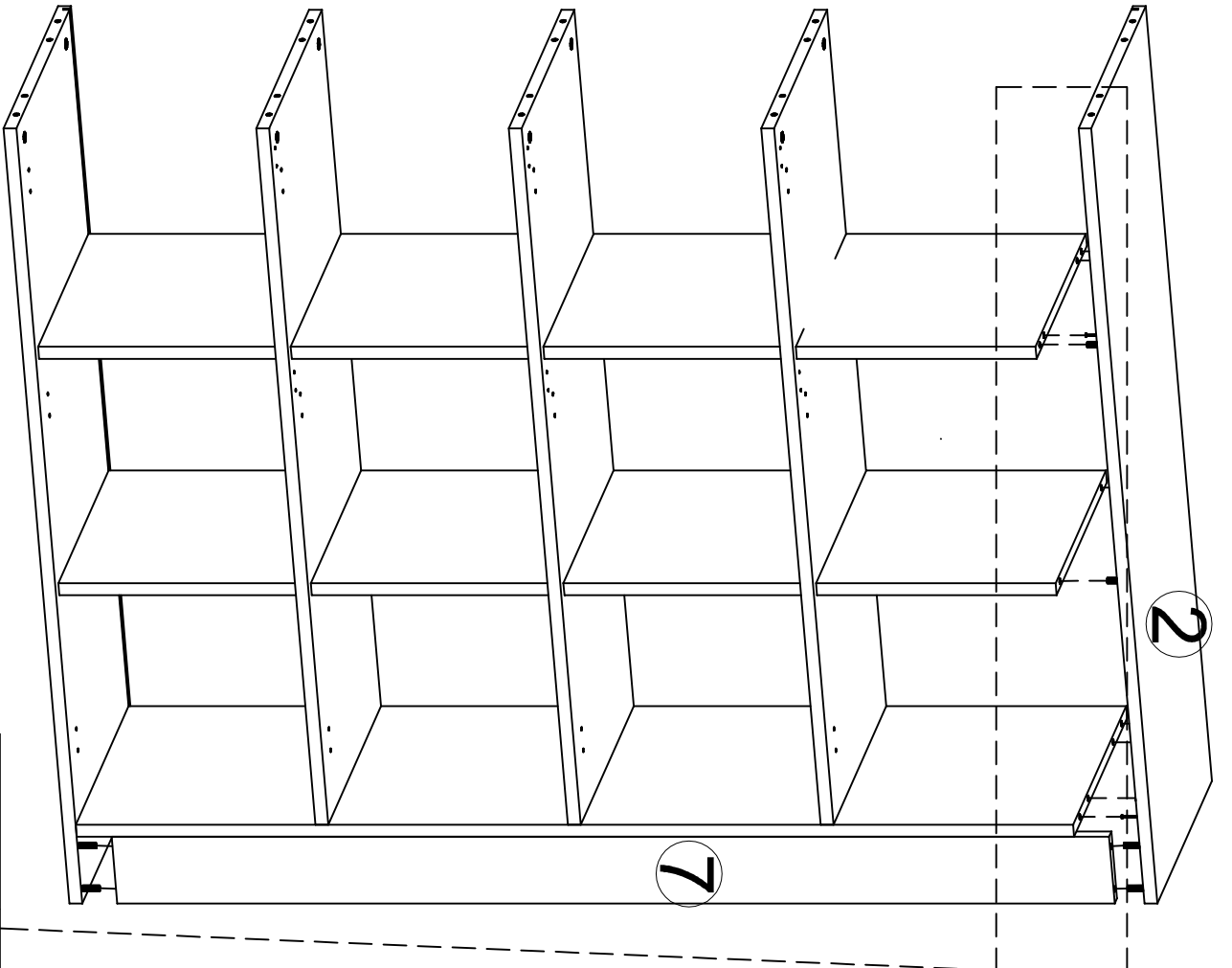

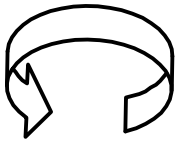
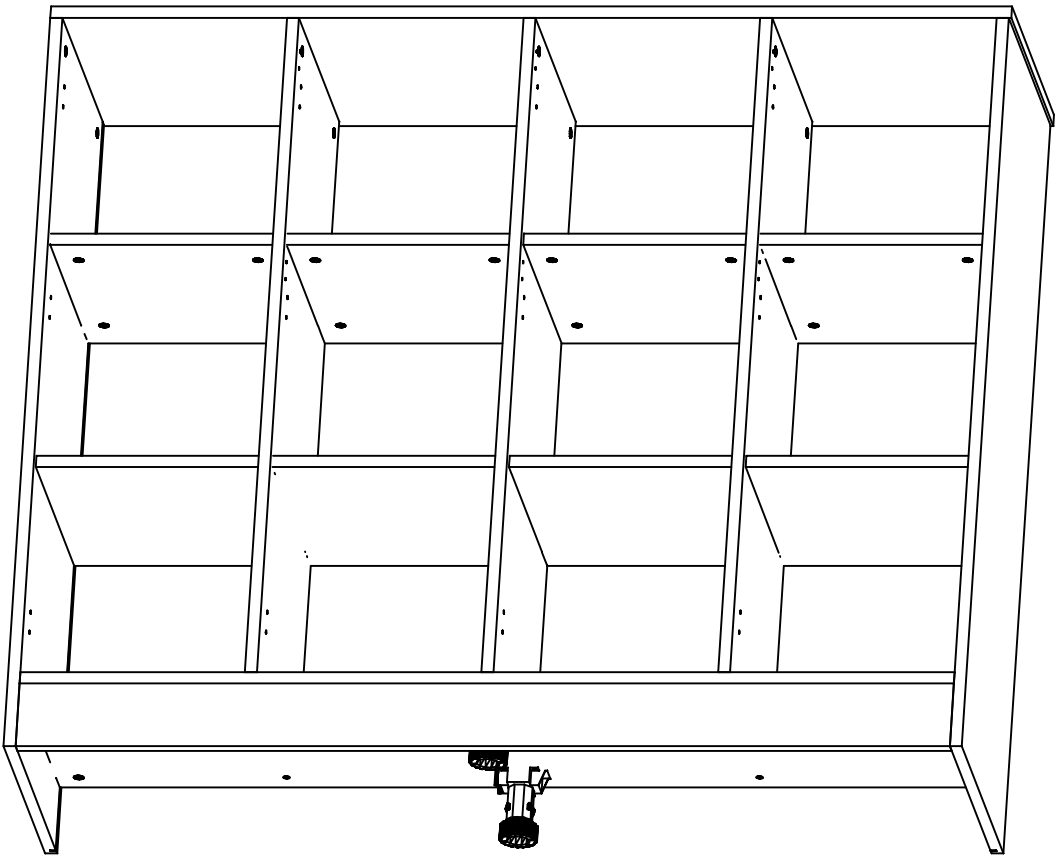

9

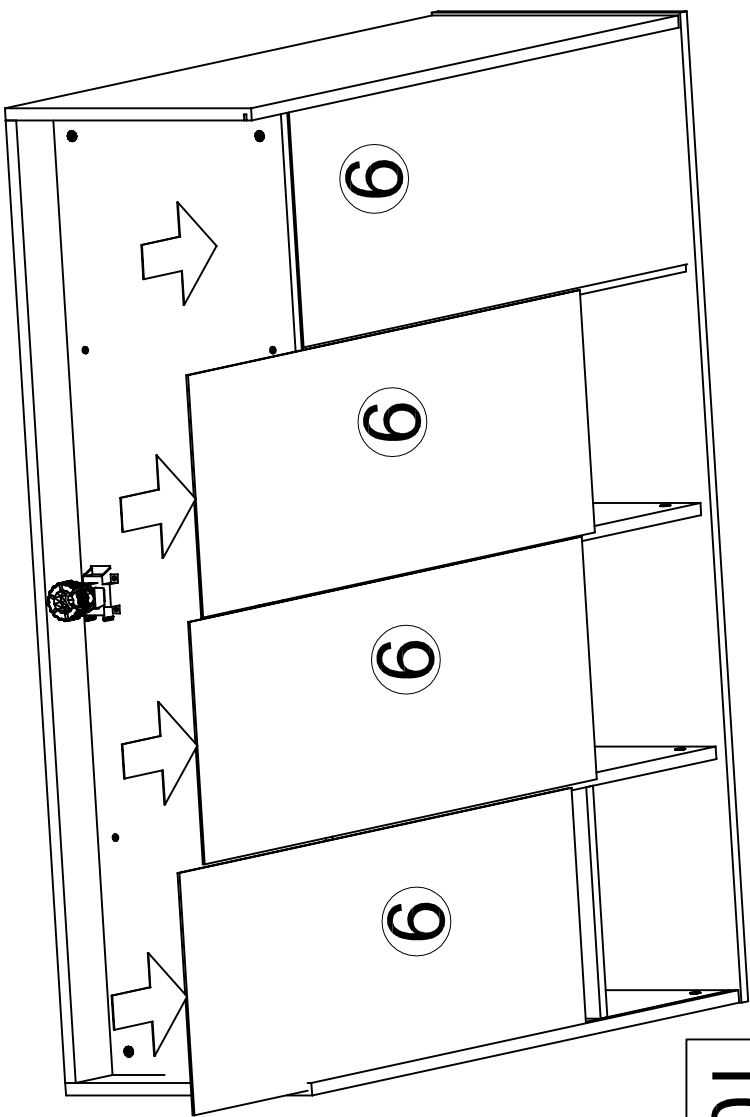

10

A = B

A

B

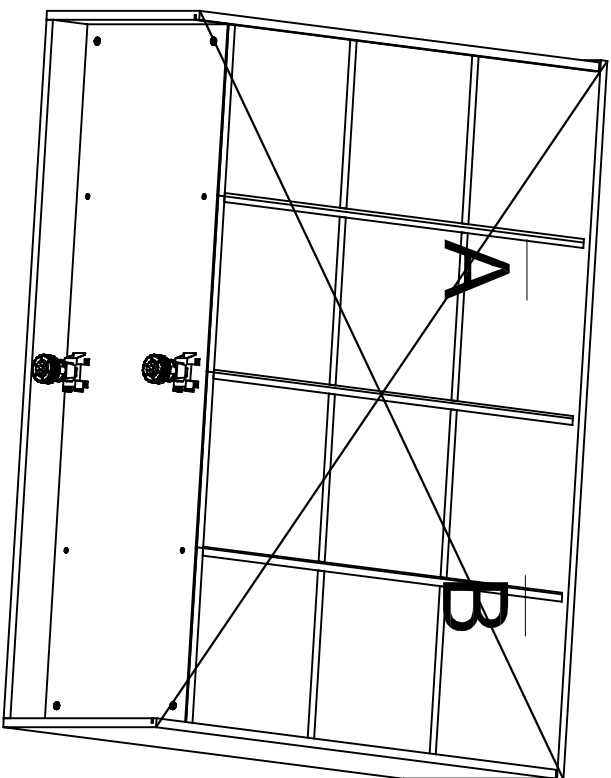

11

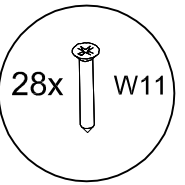
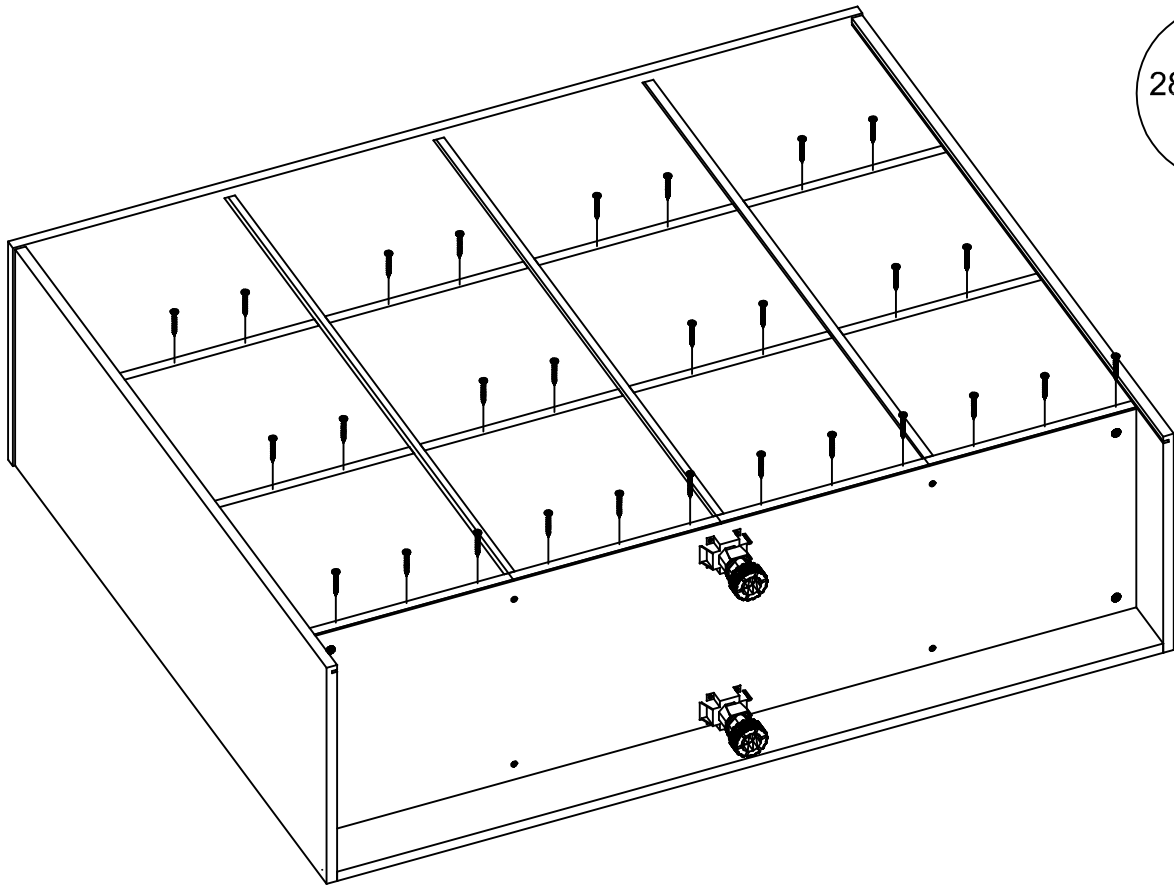

12

13

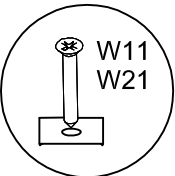
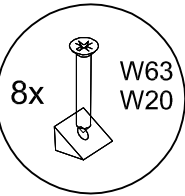
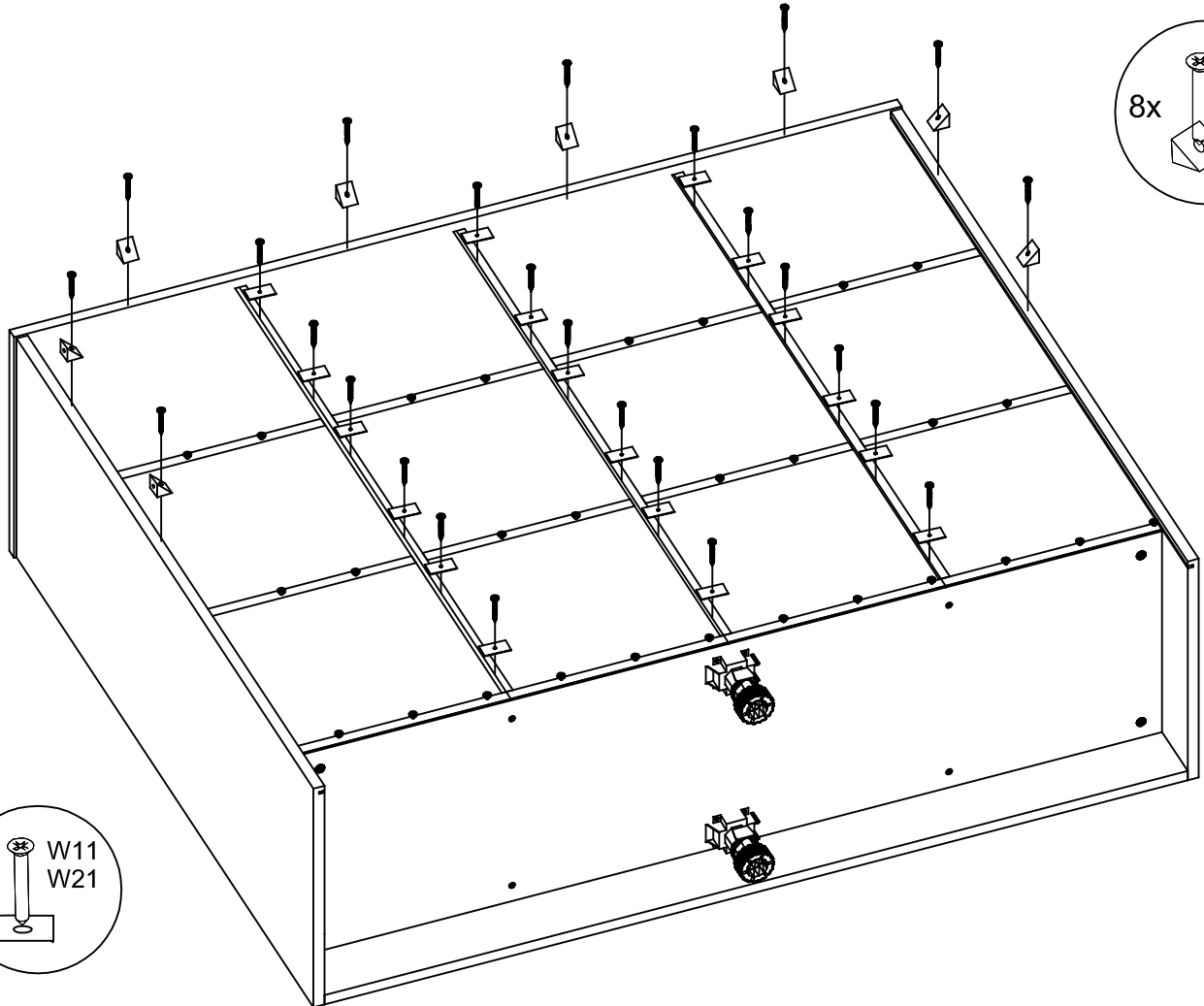

REGAL 145 3PF

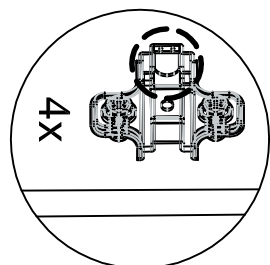
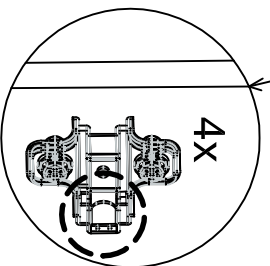
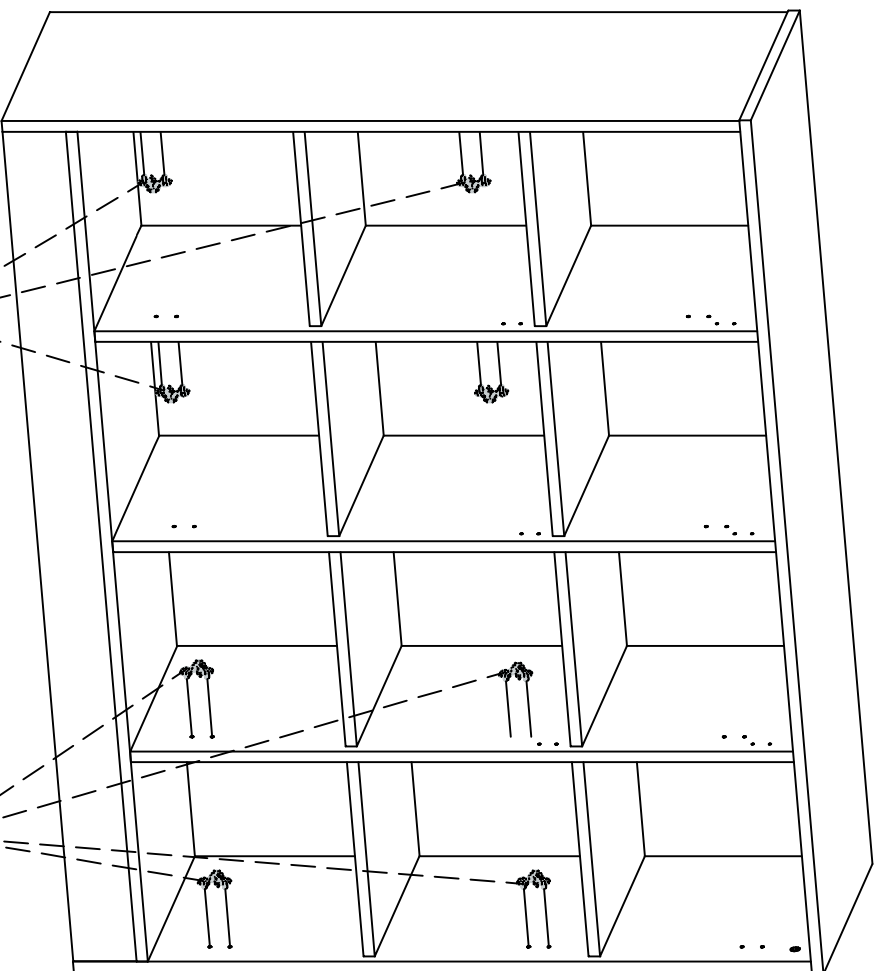

REGAL 110 3PF

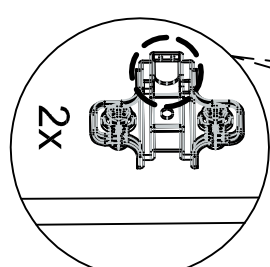
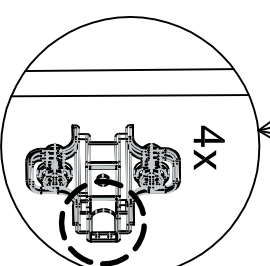
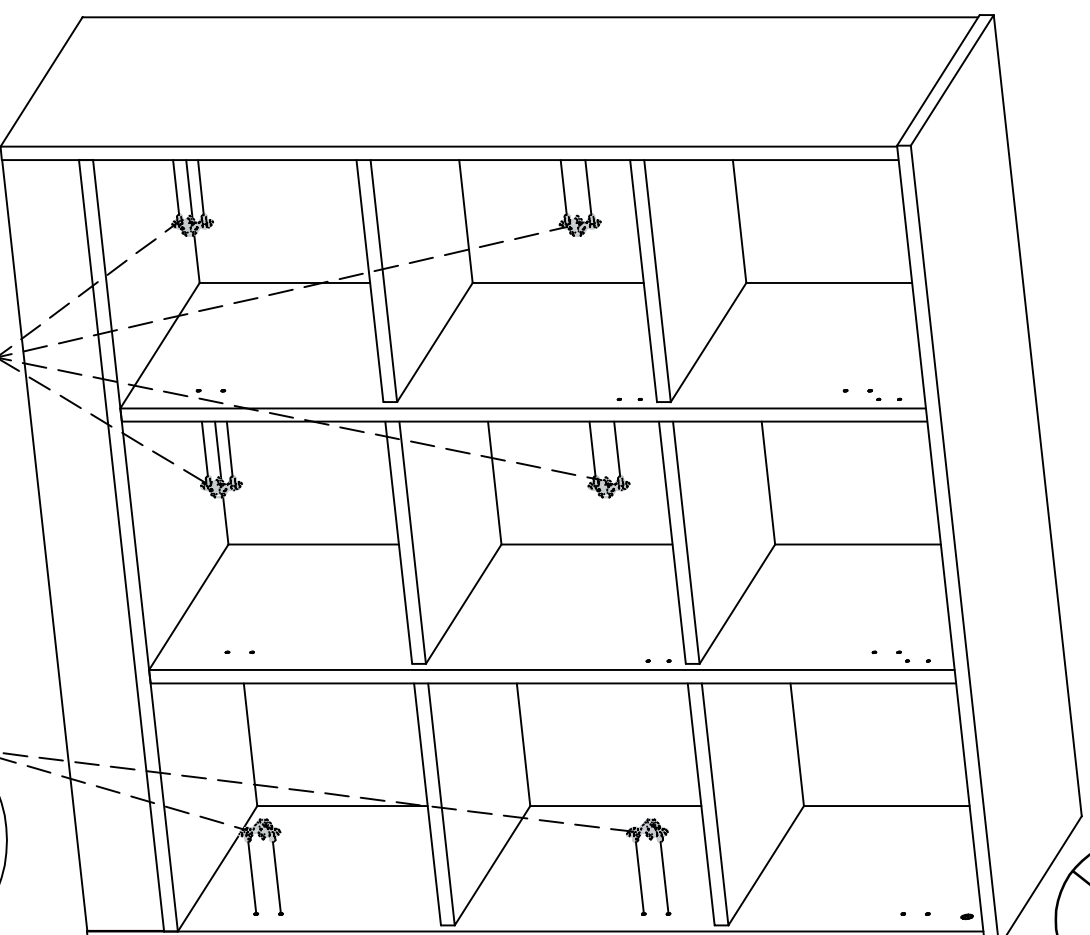
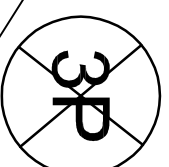

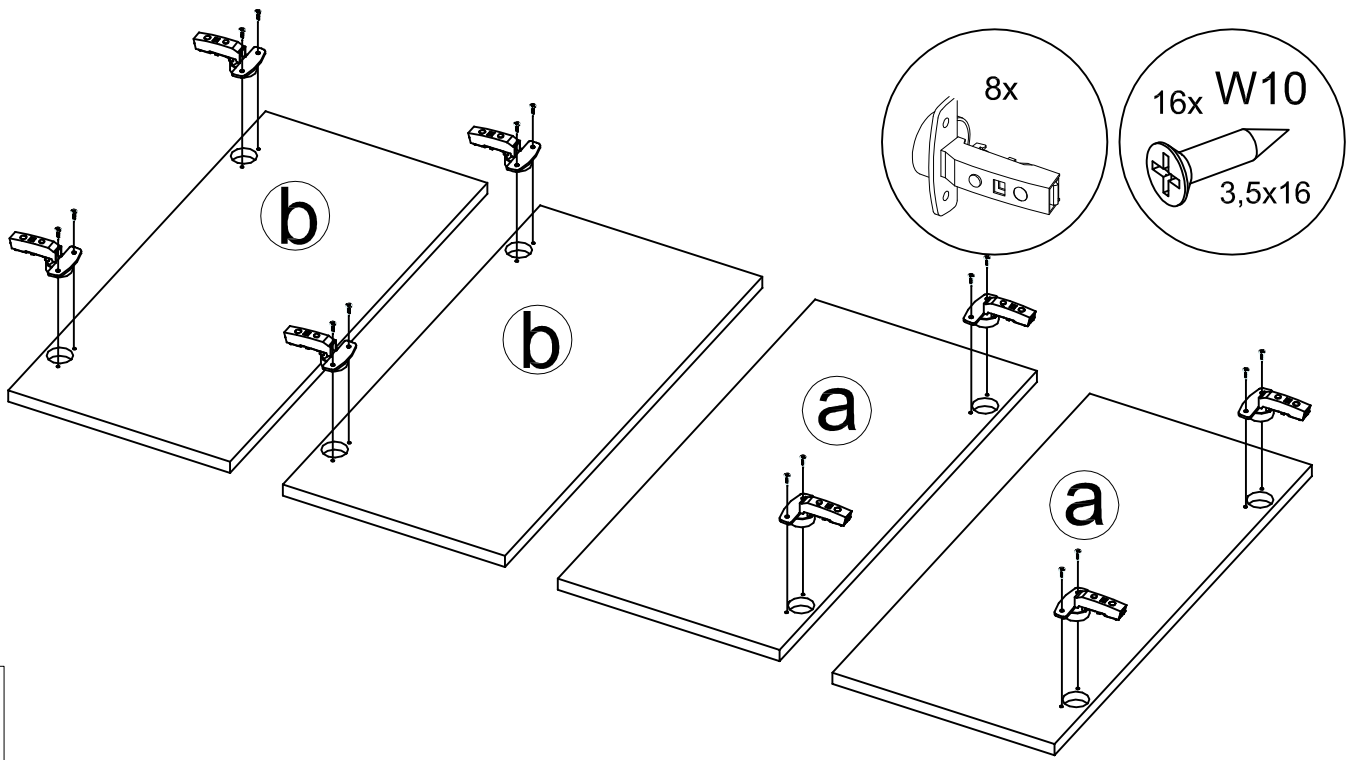

15

16

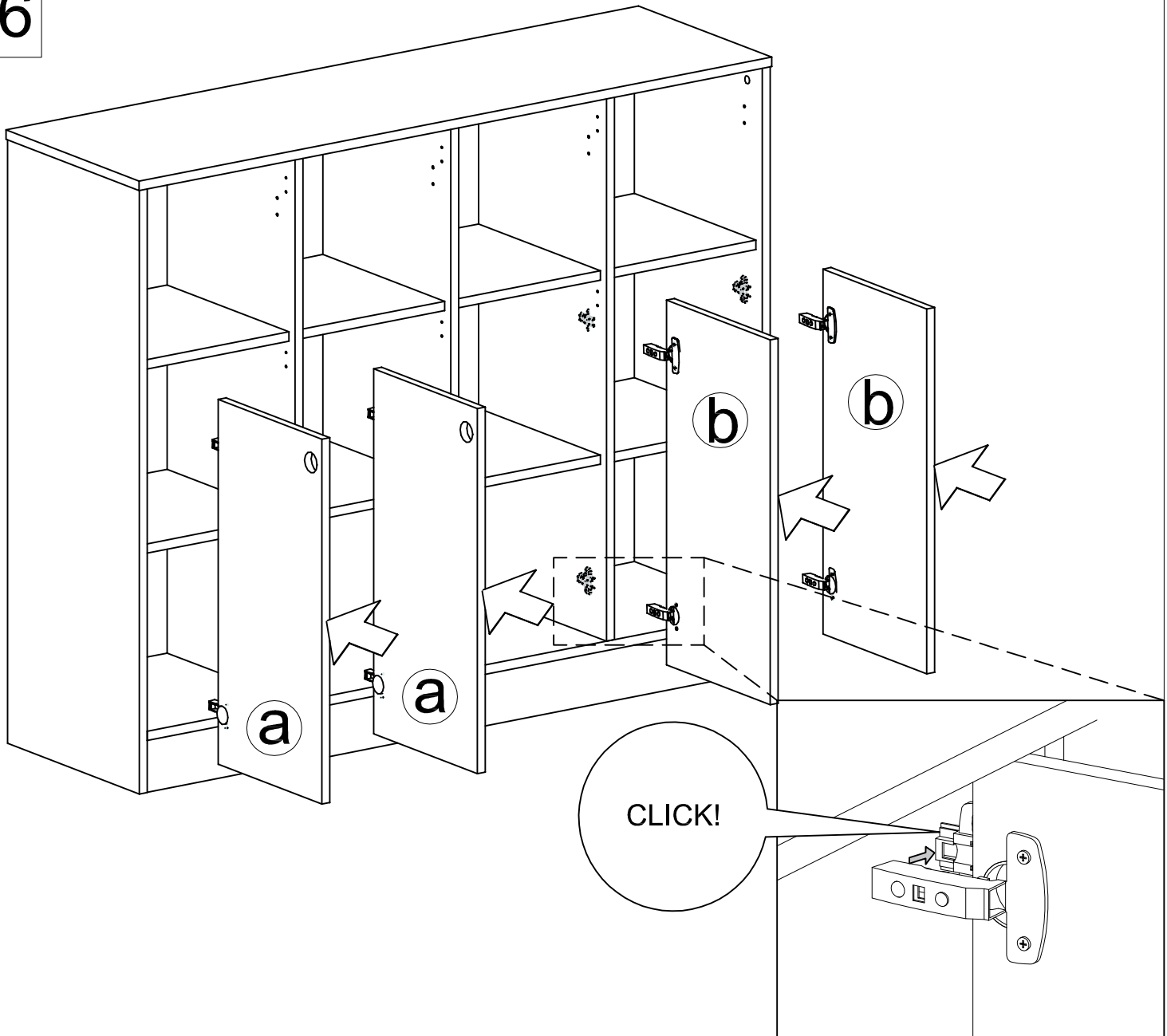

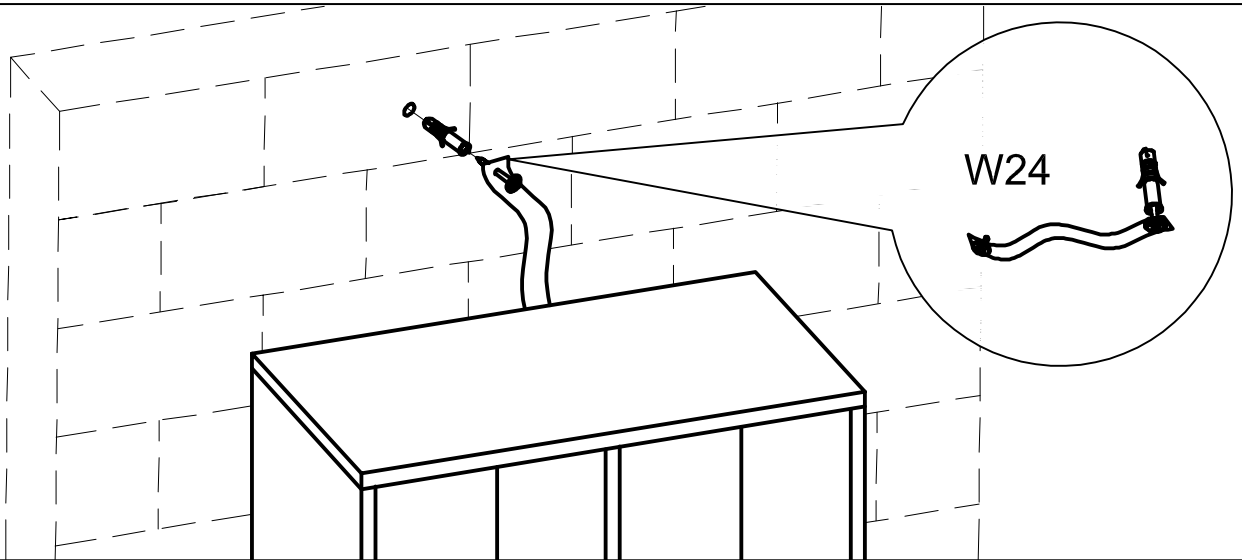

WAŻNE, ZACHOWAĆ DO PÓŹNIEJSZEGO STOSOWANIA - UWAGA PRZECZYTAĆ
INSTRUKCJA UŻYTKOWNIKA

1. Aby uniknąć niebezpieczeństwa uduszenia, trzymać opakowanie plastikowe w miejscu niedostępnym dla niemowląt i dzieci.
2. Wszystkie połączenia muszą być dobrze dokręcone, oraz żaden element łączący nie może być luźny.
3. Ostrzeżenie: Bądź świadom ryzyka, jakie stanowi otwarty ogień, oraz inne silne źródła ciepła, takie jak promienniki elektryczne lub gazowe itp. umieszczone w pobliżu regału.
4. Ostrzeżenie: Nie używać regału, jeżeli jakkolwiek jego element jest uszkodzony, rozdarty lub brakuje elementu, używać wyłącznie elementy, dopuszczone przez producenta.
5. Wszystkie elementy muszą być utrzymane w czystości.

IMPORTANT, SAVE FOR FURTHER USAGE - READ CAREFULLY
USER'S MANUAL

1. To avoid the danger of suffocation, keep the plastic packaging away from babies and children.
2. All connections must be tightened correctly and not left loose.
3. Warning: Be aware of the risk of strong sources of heat, such as electric or gas radiators etc., which may be located near a bookcase or other items of furniture as this could cause warping.
4. Warning: Do not use the bookcase if any of the sections are damaged, or if there are any missing items. Use only those items that are supplied by the manufacturer.
5. All items must be kept clean.

ВАЖНО: СОХРАНИТЬ ДЛЯ ДАЛЬНЕЙШЕГО ИСПОЛЬЗОВАНИЯ, ВНИМАТЕЛЬНО
ПРОЧИТАТЬ
РУКОВОДСТВО ПО ЭКСПЛУАТАЦИИ

1. Во избежание риска удушья, хранить полиэтиленовую упаковку в недоступном для детей и новорожденных месте.
2. Все крепления должны быть плотно затянуты, а детали прочно соединены между собой.
3. Предупреждение: Необходимо принимать во внимание опасность открытого огня и других сильных источников теплового излучения, таких как электро - и газонагреватели, размещенных вблизи стеллажа.
4. Предупреждение: Не использовать стеллаж, если какой-либо его элемент поврежден, разорван или не хватает деталей. Использовать исключительно элементы, допущенные производителем.
5. Все элементы необходимо содержать в чистоте.

IMPORTANT- PASTRATI INSTRUCȚIUNILE PENTRU UTILIZARE ULTERIOARA. CITI ȚI CU ATENȚIE
ACESTE INSTRUCȚIUNI ÎNAINTE DE ASAMBLARE
MANUALUL UTILIZATORULUI

1. Pentru a evita pericolul de sufocare, nu lăsați ambalajul de plastic la îndemâna bebelușilor și a copiilor.
2. Toate conexiunile trebuie să fie strânse corect și nu trebuie lăsate libere.
3. Atenție: Fiți conștienți de riscul unor surse puternice de căldură, cum ar fi radiatoarele etc., care pot fi situate în apropierea etajerei sau a altor piese de mobilier, deoarece acest lucru le-ar putea cauza deteriorari majore.
4. Atenție: Nu utilizați etajera dacă oricare dintre secțiuni este deteriorată sau în cazul în care există elemente care lipsesc. Utilizați numai acele elemente care sunt furnizate de către producător.
5. Toate elementele trebuie să fie păstrate curate.

WICHTIGE HINWEISE, FÜR DIE SPÄTERE NUTZUNG AUFBEWAHREN- GENAU LESEN
BEDIENUNGSANWEISUNG

1. Die Kunststoffverpackung an einem für die Kinder nicht zugänglichen Ort halten, um das Risiko des Erstickens zu vermeiden.
2. Alle Verbindungen müssen richtig hergestellt werden, kein Verbindungsteil darf lose sein.
3. Warnung: Seien Sie sich des Risikos, das ein offenes Feuer sowie andere Wärmequellen wie elektrische Wärme- oder Gasstrahler usw., gestellt in der Nähe des Regals, darstellen, bewusst.
4. Warnung: das Regal nicht benutzen, wenn ein Teil beschädigt, gerissen ist oder fehlt, nur die vom Hersteller zugelassenen Teile verwenden.
5. Alle Teile sind sauber zu halten.

TÄRKEÄÄ - SÄILYÄ MYÖHEMPÄÄ KÄYTTÖÄ VARTEN. LUE KÄYTTÖOHJEET TARKKAAN ENNEN
KALUSTEIDEN KOKOAMISTA
KÄYTTÖOHJEET

1. Välttääksesi tukehtumisvaaran, pidä muovipakkaukset poissa vauvojen ja lasten lähettyviltä.
2. Kaikki kiinnitykset tulee kiristää oikein, eikä niitä saa jättää löysiksi.
3. Huomio: ole tietoinen voimakkaista lämmönlähteistä, kuten sähkö- ja kaasupattereista jne., jotka saattavat sijaita kirjahyllyn tai muiden kalusteiden lähellä, sillä tämä saattaa aiheuttaa materiaalien taipumista.
4. Huomio: älä käytä kirjahyllyä, jos jokin osa on vaurioitunut tai jos siitä puuttuu osia. Käytä vain valmistajan toimittamia osia.
5. Kaikki osat tulee pitää puhtaana.